

H4034



GB | EMOS GoSmart Video Doorbell IP-21PoE



Contents

Safety Instructions and Warnings	2
Package Contents	3
Technical Specifications	4
Device Description	5
Installation and Assembly	6
Controls and Functions	15
Troubleshooting FAQ	24

Safety Instructions and Warnings



Read the user manual before using the device.



Follow the safety instructions provided in the manual.

Electrical hazard:

- Improper installation and/or use may cause a fire or injury by electric current.
- Before installing, read the manual and take into account the specific properties of the space and location where the product will be installed.
- Do not open, disassemble, modify or alter the device unless there is a specific instruction to do so in the manual.
- Any unauthorised opening or repair voids all liabilities, rights to replacement or warranties.
- Use only with the original power cable.
- The product can be powered only by voltage that matches the parameters listed for the product.
- Servicing of the product may only be performed by a qualified technician to minimise the risk of injury by electric current.
- Disconnect the product from the power supply before cleaning.
- The product must not be used by persons (including children), whose physical, sensory or mental capabilities or lack of experience and knowledge prevent safe use of the product without supervision or instruction.
- Cleaning and user maintenance must not be performed by unsupervised children.
- Do not submerge the product in water or other liquids.

Fire hazard:

- Do not use the product if any of its parts are damaged or defective. Immediately replace the product if it is damaged or defective.

Suffocation hazard:

- Do not allow children to play with the packaging material. Keep the packaging material out of the reach of children.

WARNING

Trip hazard:

- The power cable and product must always be placed so that they are not in the way of commonly used walking areas.

NOTICES

- Risk of damage to the product:
- Use the product only as described in this document.
- Prevent the product from falling and protect it against impacts.
- Do not use aggressive chemical detergents to clean the product.
- Supervise children so that they do not play with the product.



Package Contents

- Video doorbell
- Chime
- Manual
- Power adapter
- PoE injector
- 5× RFID chip + 2× Programming chip
- Mounting material

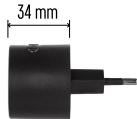
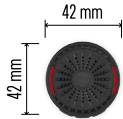

Technical Specifications

Power supply: DC 12-48 V / 1 A, PoE

(Power over Ethernet)

Connection: 802.11 b/g/n @ 2.4 GHz

Resolution: 1920×1080

Sensor: 1/2.9" CMOS

Dimensions: 68 × 138 × 38 mm

Enclosure rating: IP44

Operating temperature: -20 °C ~ +50 °C

Device Description

Description of the Camera Unit

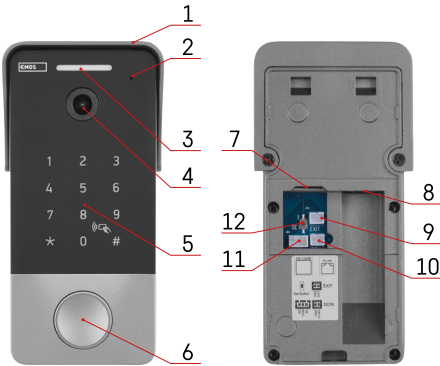

1 – Rain cover

2 – Microphone

3 – Night illumination

4 – Lens

5 – RFID reader + Keypad

6 – Illuminated bell button

7 – SD card slot

8 – RJ45 (LAN / PoE) port

9 – Connector for exit button

10 – Connector for power supply

11 – Connector for lock control

12 – SET button

Connection

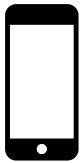

✓ 2.4 GHz

5 GHz ✗

Attention

The device can only connect to a Wi-Fi with 2.4 GHz frequency. (5 GHz frequency is not supported.) We therefore recommend that you check that your Wi-Fi network operates on this frequency before connecting your device. Some routers have both 2.4 GHz and 5 GHz frequencies merged under one SSID. In that case, it may be necessary to separate the frequencies so that the device can connect

Installation and Assembly

Description of Wiring

Method 1: Power and data over PoE (Power over Ethernet)

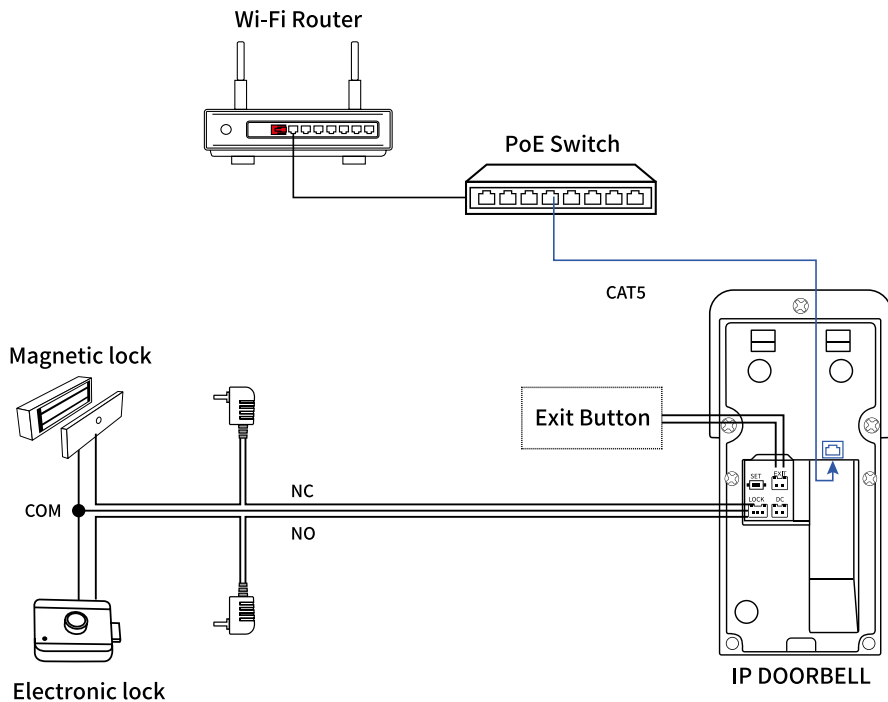

This option is best suited for new buildings or renovation projects where it is easy to run a single Ethernet cable from the router or PoE switch to the doorbell. It provides the most stable connection and power supply without the need for additional cables. It is necessary to use a data cable of at least category CAT5.

If a PoE switch is not available, it can be substituted by the included PoE injector. The injector connects as follows:

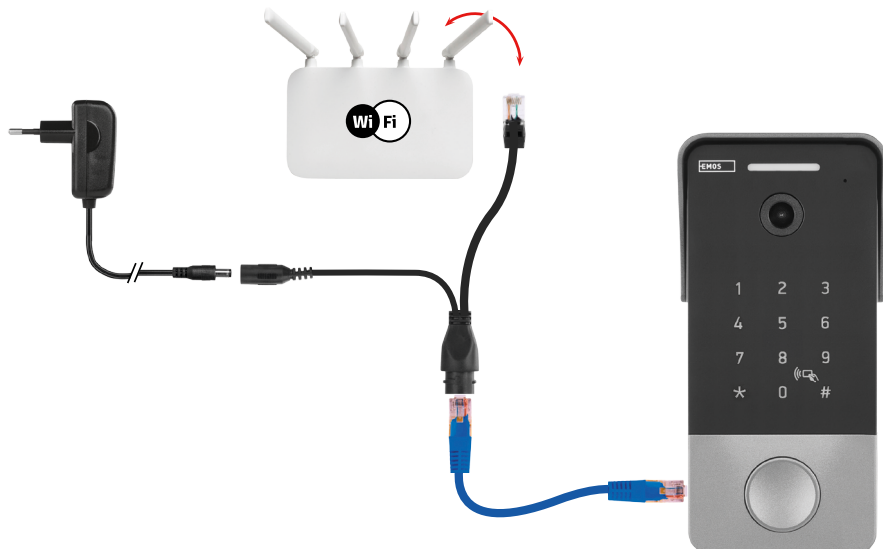

Method 2: Power supply via separate cable + data via LAN cable

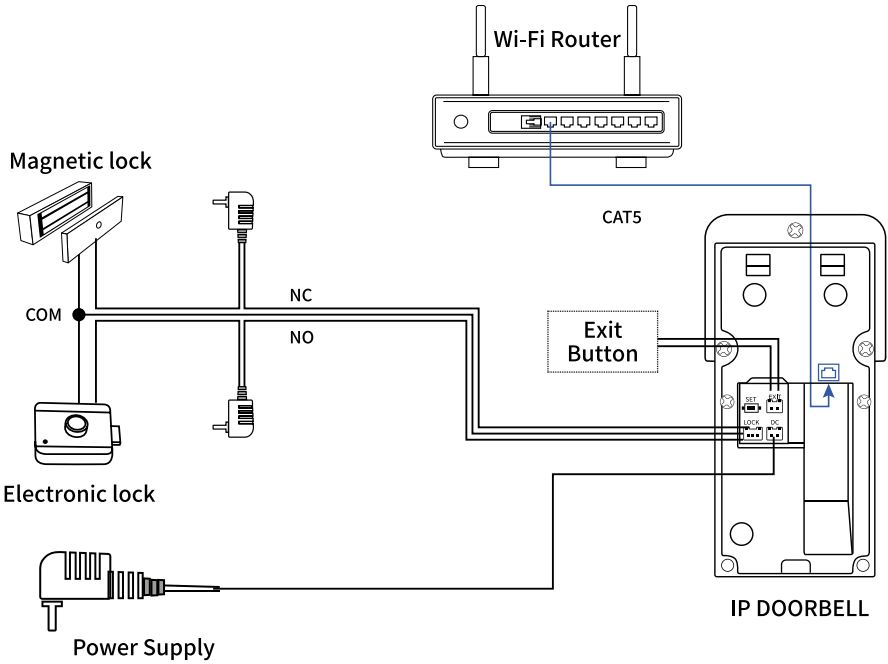

Suitable for locations where it is easy to run a data cable, but there is no PoE switch available and no PoE injector can be used – for example, due to the connection method or insufficient infrastructure. In this case, the power supply is handled by a separate cable, for example from an adapter or a switchboard.

Graphical representation of connection using the enclosed adapter:

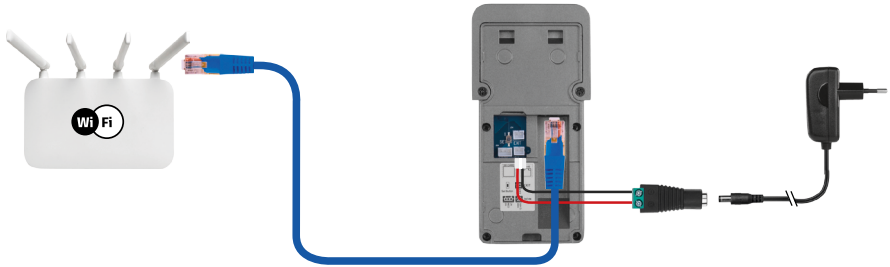

Method 3: Power supply via separate cable + Wi-Fi

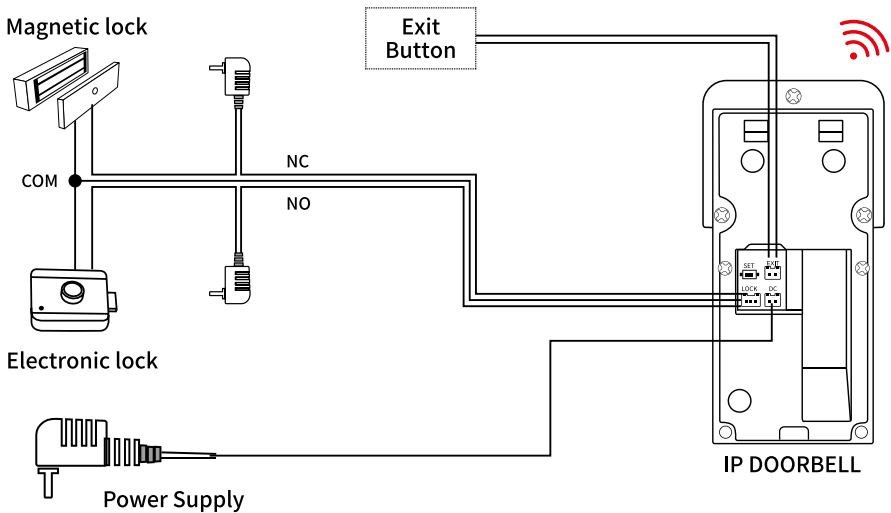

This option is suitable for locations where it is not possible to run a network cable, but a stable Wi-Fi connection is available. The power supply is provided by a separate cable.

Attention: Due to the robust metal design of the entire video doorbell, Wi-Fi range is significantly limited - approximately 15-20 metres in an open space. For proper operation, it is therefore necessary to ensure a sufficiently strong Wi-Fi signal at the mounting site, ideally without any obstacles between the doorbell and the router.

Graphical representation of connection using the enclosed adapter:



Mounting of the Video Doorbell

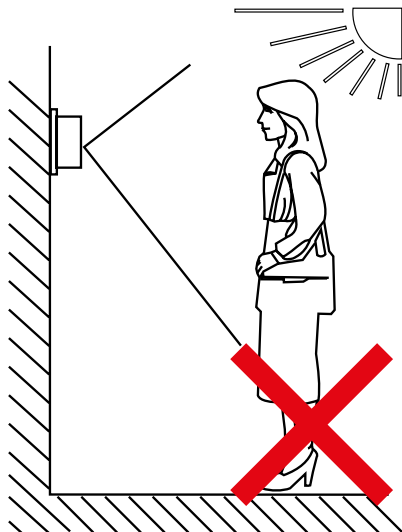
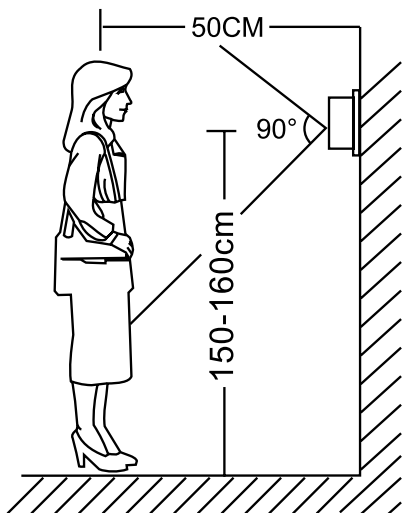

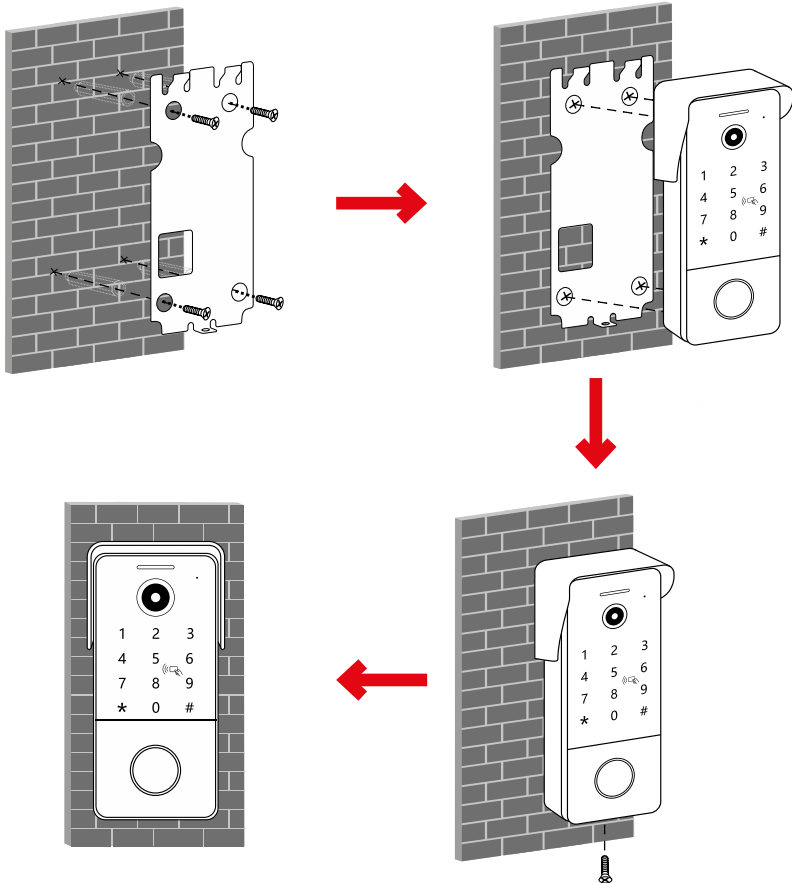

1. Choose a suitable mounting location 150–160 cm from the ground, ideally out of direct sunlight, and fasten the mounting frame there.
2. Pull the power supply cable through the mounting opening and connect it to the terminal on the back of the camera unit.
3. Mount the connected camera unit onto the mounting frame using the enclosed screw.
4. Apply a layer of silicone between the wall and the camera unit to prevent ingress of humidity under the door camera unit. The silicone should be applied on the top and the sides. The bottom side must be left open to allow humid air to exit the space under the door camera unit.



Pairing with the Indoor Chime

The video doorbell is compatible with the classic P5734B wireless chime. In the event of a malfunction or need for expansion, this chime can be purchased separately under product number P5734B and easily paired by following the procedure below.

Plug the chime into a suitable electrical socket.



After initialisation, hold the center button for 5 seconds until red LEDs light up.



Press the ring button on the video doorbell – the chime should automatically pair and start ringing. After successful pairing, you can use the control buttons on the chime to adjust the volume and select the ringtone. A short press of the middle button changes the volume level, and the arrow buttons can be used to scroll through the different ringtones.

Controls and Functions

Pairing RFID Chips

Included in the package is a set of 7 RFID chips: 5× black for normal use (unlocking) and 2 coloured – red and green – for management. The green chip is used to add new (black) chips, the red chip to delete them.



1. Place the green chip against the doorbell's reading surface. A beep will sound – the device enters chip adding mode.
2. Gradually place the new (black) chips you want to save. Each successful addition is confirmed by a beep.
3. After adding all the desired chips, place the green chip again to exit adding mode. The beep will sound again.



The same procedure can be used to delete chips – first place the red chip to start the removal mode, then gradually place the chips you want to remove, and finally place the red chip again to exit the mode.

Erasing All RFID Chips

If you lose one of the RFID chips and have no way to remove it separately, we recommend that you erase all the chips at once to avoid security risks.

To do this, hold the SET button for 3 seconds, then release it and press it briefly 3 times.

This step deletes all paired RFID chips from the video doorbell, including the red and green admin chips.

In case you need to re-pair these chips, please contact our technical support at: support@emos.eu.

Settings Using the Keypad

Quick Reference Coding Table

Function	Step 1	Step 2	Step 3	Note
Enter programming mode	Master #			The default admin (Master) code is set to 123456
Exit programming mode	*			
Change admin (Master) code	0 #	New code #		
Add an unlock code	1 #	User ID #	New PIN #	
Clear an unlock code	2 #	User ID #		Clear all codes 9 9 #
Add RFID chips	3 #	RFID number #	Read RFID	
Erase RFID chips	4 #	RFID number #		Clear all chips 9 9 #
Keypad backlighting mode	7 #	0 0 # - Off 0 1 # - On 0 2 # - On during activity		
Set unlock relay activation duration	8 #	1~9 #		

Programming Mode

To set up the various functions, you must first put the device into programming mode. You can do this by entering a number combination as follows:

Entering programming mode (admin code): **1 2 3 4 5 6 #**

You will hear one long beep when you enter programming mode.

Exiting programming mode: *****

Exiting programming mode is indicated by a double beep.

Changing the Admin Code

We strongly recommend that you change the admin code first before making any further settings to avoid security risks.

1. Enter programming mode
2. Input: **0 #**
3. Enter a new 6-digit password: **New code #**
Successful change is indicated by 1 long beep
4. Exit programming mode

Adding an Unlock Code

1. Enter programming mode
2. Input: **1 #**
3. Enter the code's ordinal number (000-199): **User ID #**
4. Enter a 6-digit unlock code and confirm by pressing the # button: **New PIN #**
If the save was successful, you will hear one long beep as confirmation.
If the specified ordinal number (memory position) is already occupied, a short double beep will sound and the whole procedure will have to be repeated.
5. Once you hear the confirmation tone (one long beep), you can add more passwords one at a time. Each newly entered password is automatically stored under the next ordinal number.
6. To exit programming mode, press the * button twice: *** ***

Clearing an Unlock Code

1. Enter programming mode
2. Input: **2 #**
3. Enter the ordinal number of the code (000-199) from which you wish to remove the password and confirm by pressing the # button: **User ID #**
The password stored in this position will be deleted. One long beep sounds after successful removal.
4. Once you hear the confirmation tone (one long beep), you can delete more passwords one at a time by pressing #. This will automatically select the password in the next ordinal number for deletion.
5. If you wish to delete all unlock passwords, enter 99 instead of the ordinal number and confirm by pressing the # button. This will remove all unlock passwords. **9 9 #**
6. To exit programming mode, press the * button twice: *** ***

Adding an RFID Chip

1. Enter programming mode

2. Input: **3 #**

When the doorbell is switched on again, the device will be in RFID chip adding mode for 1 minute. You will hear one long beep.

3. Enter the code ordinal number (000-199): **RFID number #**

The ordinal number 000 is reserved for the adding RFID (admin) chip and 001 for the erasing RFID chip.

4. Place the new RFID chip on the reader. You will hear one long beep to indicate a successful chip save.

Read RFID

If the chip is already stored in the door station's memory, a short double beep will sound.

5. Once you hear the confirmation tone (one long beep), you can place more chips one at a time. Each new chip is automatically stored under the next ordinal number.

6. To exit programming mode, press the * button twice: *** ***

Deleting an RFID Chip

1. Enter programming mode

2. Input: **4 #**

You will hear one long beep.

3. Enter the code's ordinal number (000-199) and press # to delete the chip: **RFID number #**

4. Once you hear the confirmation tone (one long beep), you can delete more chips one at a time by pressing #. This will automatically select the chip in the next ordinal number for deletion.

5. If you wish to delete all chips, enter 99 instead of the ordinal number and confirm by pressing the # button. **9 9 #**

6. To exit programming mode, press the * button twice: *** ***

Keypad Backlight Setting

1. Enter programming mode

2. Input: **7 #**

You will hear one long beep.

3. Select the backlighting mode:

0 0 # – Backlight always off

0 1 # – Backlight always on

0 2 # – The backlight only turns on when the keypad is in use and automatically turns off after a period of inactivity.

4. Exiting programming mode: *****

Exiting programming mode is indicated by a double beep.

Setting the Activation Duration of the Unlock Relay

1. Enter programming mode

2. Input: **8 #**

You will hear one long beep.

3. Enter a number from 1 to 9 that indicates the relay activation duration in seconds: **1~9 #**

4. Exit programming mode: *****

Exiting programming mode is indicated by a double beep.

Pairing with the App

Installing the EMOS GoSmart App



The app is available for Android and iOS on Google Play and App Store. Download the app by scanning the QR code.

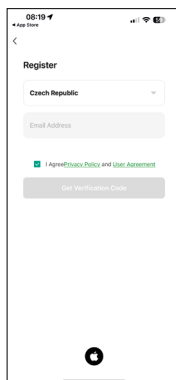
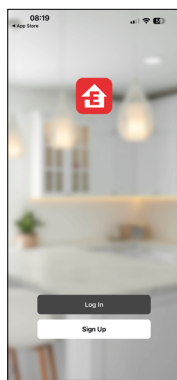
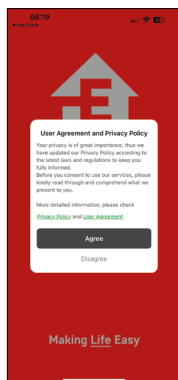

Open EMOS GoSmart and confirm the privacy policy by tapping Agree.

Choose Sign Up.

Enter a valid e-mail address and choose a password.

Confirm that you agree to the privacy policy.

Choose Log In.

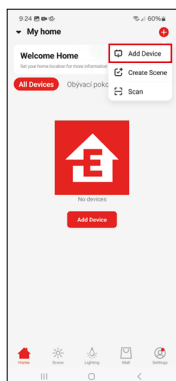
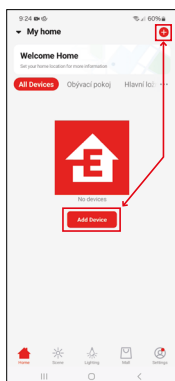

Choose Add Device.

Choose the GoSmart product category and choose device PoE Video Doorbell IP-21

Pairing a Video Doorbell Connected via Data Cable (Method 1 + Method 2)

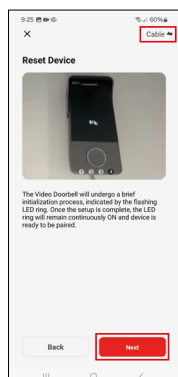
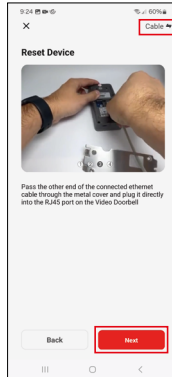
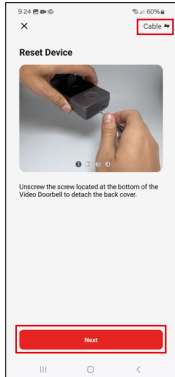

Unscrew the screw at the bottom of the video doorbell and remove the back cover.
Connect the device to the PoE switch. If using a PoE injector, connect the cables as described in installation method 1.
Connect the other end of the data cable directly to the video doorbell.
The device performs a short initialization, which is indicated by a flashing LED ring. Once initialization is complete, the LED ring will remain permanently lit and the device will be ready to pair.

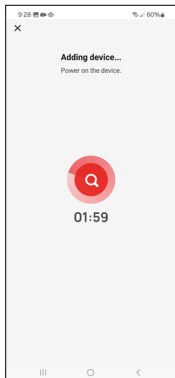

The device will be detected automatically.
The device has been found. Confirm by tapping Done.

Pairing a Video Doorbell Connected via Wi-Fi (Method 3)

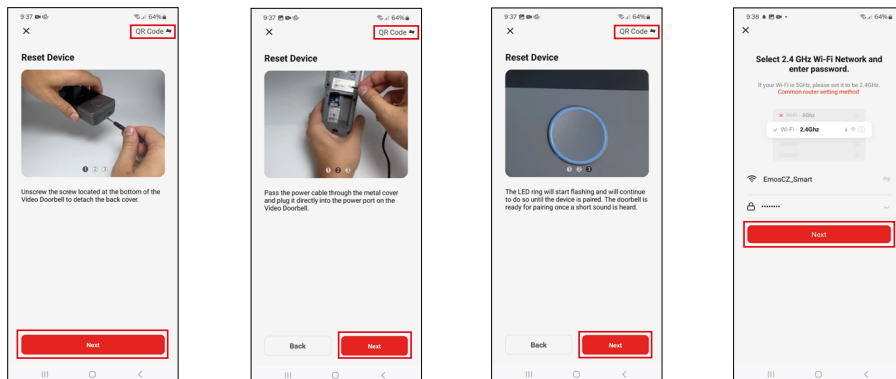

In the top right corner, change the pairing method from "Cable" to "QR Code". Unscrew the screw at the bottom of the video doorbell and remove the back cover. Connect the power cable. The LED ring will be flashing until the device is paired. The video doorbell is ready to pair the moment you hear a short tone. Enter the name and password to your Wi-Fi network. The information remains encrypted and is used only so that the video doorbell is able to communicate with your mobile device remotely.

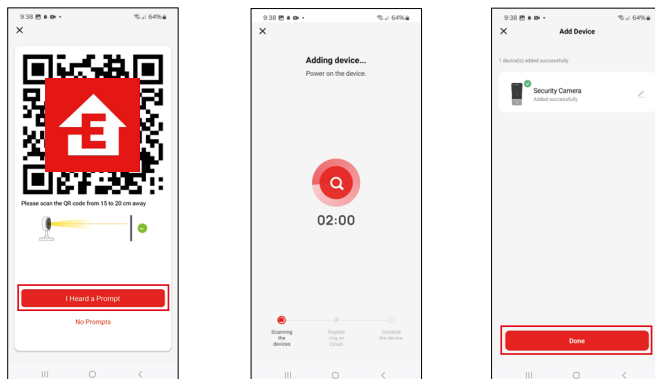

Point the generated QR code at the video doorbell camera and hold it until you hear a ringtone. When this sound is heard, tap the button to continue. The device will be detected automatically. Confirm by tapping Done.

Icons and Indicators

Description of Indicators in the Application

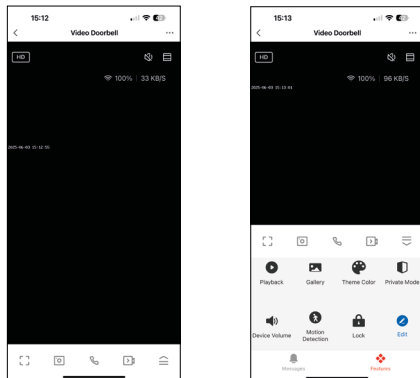

...	Advanced Settings
	Video quality switch (HD / SD)
	Mute
	Zoom
	Signal quality and speed
	Fullscreen mode
	Take pictures using the app and save them in the mobile album
	Speak
	Capture video using the app and save it in the mobile album
	Open the menu
	Play video stored on the SD card
	View videos and photos taken through the app
	Light mode / dark mode
	Private mode – the device will stop scanning and recording
	Volume setting
	Motion detection – the device will notify you if it detects any movement
	Lock control
	Edit icons + option to add control for another device
	Display notifications (Motion detection...)

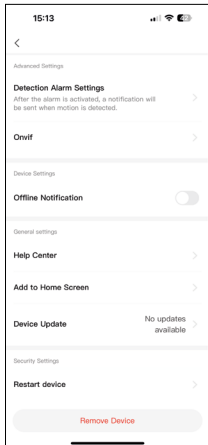
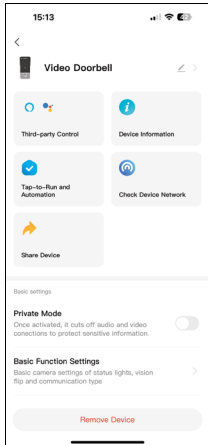

Description of Advanced Settings

- Third-Party Control – Voice assistant settings
- Device Information – Basic information about the device and its owner
- Tap-to-Run and Automation – View scenes and automations assigned to the device. Scenes can be created directly in the app's main menu in the Scenes section.
- Check Device Network – Network diagnostics
- Share Device – Option for sharing the administration of the device with another user
- Private Mode – When activated, the device stops scanning and recording
- Basic Function Settings – Option to turn on/off basic functions of the device such as automatic screen rotation or watermark with time and date. An important setting is also the option to choose between one-way or two-way communication.
- Volume and Sounds – Volume settings
- Detection Alarm Settings – Alarm settings.
- Activity Area – Sets the zone in which the device will detect movement. For instance, if your device is pointed towards a road and you do not want to be notified every time a car passes by, you can set which area the motion detection should focus on.
- Human Body Filtering – Detection of human silhouettes. Once the function is activated, the device should no longer notify you of all movement, only if it detects a human body moving.
- Onvif – Basic settings of the Onvif function for connecting the device to external browsers, such as NVR systems.
- Offline Notification – To avoid constant notifications, a notification will be sent if the device remains offline for more than 30 minutes.
- Help Center – displays frequently asked questions and their solutions and provides the option to send us a question, suggestion or feedback directly
- Add to Home Screen – Adds an icon to the home screen of your phone. That way, you no longer need to open the device through the app every time; you simply tap the newly added icon and you will be redirected straight to the device's menu
- Device Update – Updates the device. Option to turn on automatic updates
- Restart Device – Restarts the device
- Remove Device – Remove and unpair the device. An important step if you wish to change the owner of the device. Once a device is added to the app, the device is paired and cannot be transferred to another account without unpairing.

Recording onto an SD Card

One of the core functions of a home security system is the ability to record onto an SD card. The video doorbell supports SD cards with a maximum capacity of 128 GB in FAT32 format. Once the card is full, data will automatically start overwriting.

Instructions on how to activate the SD card function:



1. Insert the Micro SD card into the appropriate slot.
2. Open the device's advanced settings and choose the "Storage settings" options.
3. Format the SD card. **ATTENTION:** do not turn off the app or interrupt the process while the card is formatting.
4. Turn on motion detection and adjust the sensitivity as needed. You can also activate/deactivate human body recognition in the settings to prevent alarms whenever the device registers an animal or tree moving. You can also use the Activity Area option to designate an area in which the device should detect movement. (For example, if you do not want the device to notify you whenever a car passes on a road that is within the device's field of view).
5. When the device detects movement, it will also record a few seconds of video, which you can then find under the  icon

Troubleshooting FAQ

The devices are not pairing. What should I do?

- Make sure the signal is sufficiently strong
- Give the app all permissions in the settings
- Check that you are using an up-to-date version of the mobile operating system and the latest version of the app

I can be heard outside but sound from the outside is not coming in / Sound from the outside is coming in but I cannot be heard outside.

- Check that you have given the app all permissions on your device, particularly when it comes to the microphone.
- Another potential issue is one-way communication. If this icon  is displayed, it means the device is set to one-way communication.
- If you want to change the setting, go to Basic Function Settings and set Talk Mode to Two-way talk. You can find the menu in the advanced settings (see chapter Description of Advanced Settings).
- The icon for two-way communication looks like this: 

I am not receiving notifications. Why?

- Give the app all permissions in the settings
- Turn on notifications in the app's settings (Settings -> App notifications)

What SD card can I use?

- The device supports SD cards up to a maximum storage capacity of 128 GB, and speed of at least CLASS 10 in FAT32 format.

When the SD card's memory is full, are the oldest recordings automatically overwritten or do I have to delete them manually?

- Yes, recordings are overwritten automatically.

Who is allowed to use the device?

- The device must always have an admin (owner)
- The admin can then share the device with other people in the household and assign them rights